



**BIRCH**  
CREATIVE



**WILD BLOOM CHEVRON QUILT  
LIBERTY.**  
FABRICS



# WILD BLOOM CHEVRON QUILT

CUSHION SIZE: 49" x 56" (125 x 142cm)

### MATERIALS:

- LIBERTY Fabrics - The Emporium Collection



REGENT ROSE-5905B - 0.75mtr  
 Cut 1 strip 4 3/4" x WOF  
 Cut 2 strips 2 5/8" x WOF  
 Cut 5 strips 3 3/4" for binding



WILD BLOOM -5901B - 0.4mtr  
 Cut 2 strips 4 3/4" x WOF  
 Cut 2 strips 2 5/8" x WOF



KYOTO POSEY-5907B - 0.25mtr  
 Cut 2 strips 4 3/4" x WOF



MERCHANT'S TREE-5911C - 0.4mtr  
 Cut 3 strips 4 3/4" x WOF



CULODDEN VINE-5910B - 0.25mtr  
 Cut 2 strips 4 3/4" x WOF



KINGLY SPRIG-5904B - 0.1mtr  
 Cut 1 strip 2 5/8" x WOF



KINGLY SPRIG-5904A - 1.3mtr  
 Cut 1 strips 2 5/8" x WOF  
 Cut 10 strips 4 3/4" x WOF



PALMERIA-5908B for backing fabric

- Batting

The fabric requirements is for making quilt as shown in the photograph. Before cutting review the placement of colours in case you want to make your own choices.



Take 2 5/8" strips and stitch them together in pairs with 1/4" seams.



1 set



2 sets





# WILD BLOOM CHEVRON QUILT

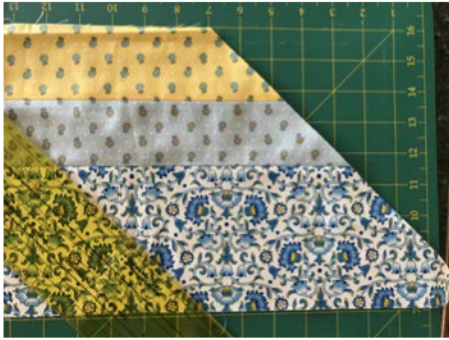

Stitch one set of strips with CULODDEN VINE strip in the manner illustrated below. Crosscut these strip set at 45 degrees angle into 6 1/2" blocks. You should be able to cut four blocks from strip set.

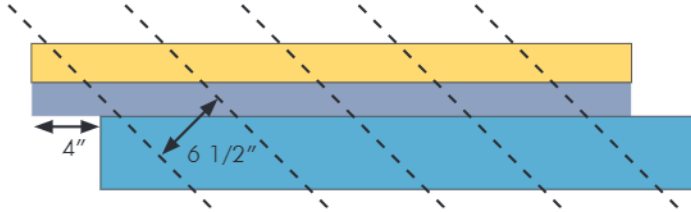



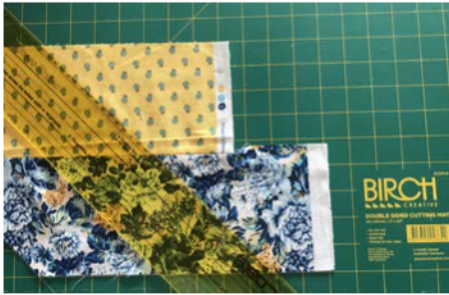
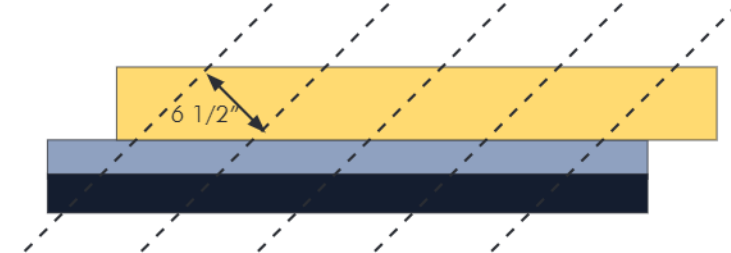



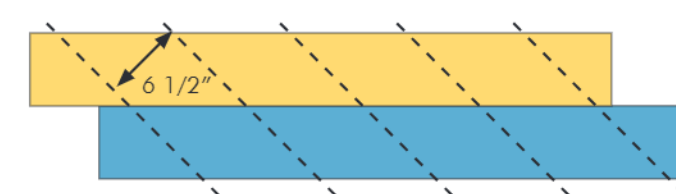

Stitch two sets of strips with KINGLY SPRIG strip in the manner illustrated below. Crosscut these strip set at 45 degrees angle into 6 1/2" blocks.



Pair four strips of KINGLY SPRIG together with strips from the KYOTO POSEY, REGENT ROSE, WILD BLOOM and CULODDEN VINE fabrics. Stitch them in the manner illustrated below. Crosscut these strip set at 45 degrees angle into 6 1/2" blocks.



- 1 strips 
- 1 strips 
- 1 strips 
- 1 strips 

- 1 strip 
- 2 strips 
- 1 strips 
- 1 strips 

Pair the rest of the strips from KINGLY SPRIG together with strips from the KYOTO POSEY, MERCHANT'S TREE, CULODDEN VINE and WILD BLOOM fabrics. Stitch them in the manner illustrated below. Crosscut these strip set at 45 degrees angle into 6 1/2" blocks.

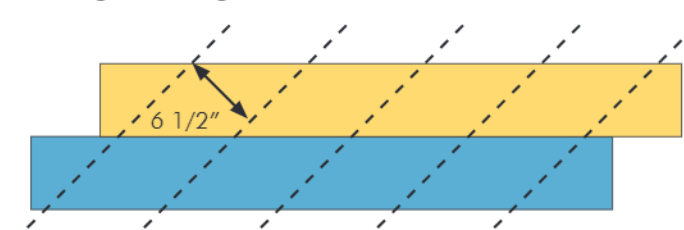

**BIRCH**  
CREATIVE

## WILD BLOOM CHEVRON QUILT

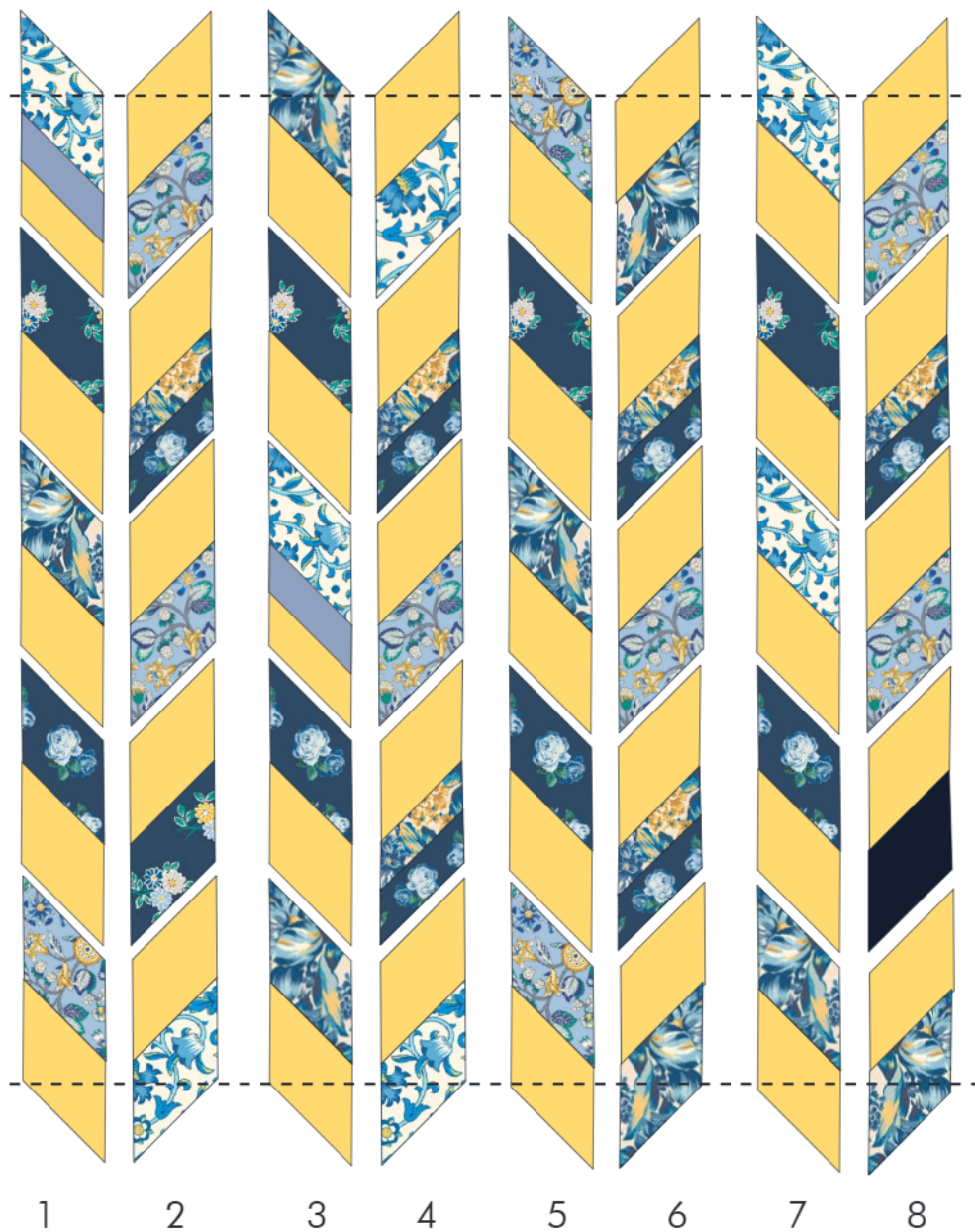

You will need 40 blocks. Lay your blocks out in 8 columns of 5 blocks. Refer to the illustration or make your own choices. You will have a few extra blocks left over from your strips.

Join blocks to form vertical columns. Join columns together. Square up the top and bottom edges of the quilt by trimming excess fabric.

### QUILT ASSEMBLY

Cut backing fabric and batting to the size of the quilt top including extra 1 1/2" on each side for wider binding.

Place backing fabric on a large surface wrong side up. Stretch it with masking tape against that surface. Place batting on top of backing fabric.

Place top of the quilt on top of the batting with right side facing up. Smooth away wrinkles using your hands.

Pin all layers together. Machine or hand quilt starting at the center and working towards the corners.





# BIRCH

CREATIVE

## WILD BLOOM CHEVRON QUILT

### BINDING

Join 3 3/4" binding strips together end to end using 45° seams. Press seams open. Start sewing the binding strip in the middle of one of the sides, placing the strip on the top of the quilt matching raw edges.

Leave a 4" - 6" tail and begin sewing the binding to the quilt top using a 1/4" seam.

Stop stitching 1/2" before the edge of the quilt.

stop stitching 1/2" from  
the edge of quilt top

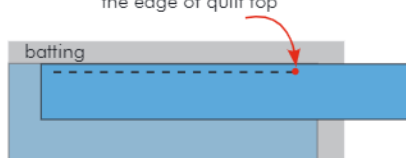

Clip the threads. Remove the quilt from under the machine foot. Fold the strip in a motion of 45° and upward, pressing with your fingers. Hold this fold with your finger, and bring the strip down in line with the next edge, making a horizontal fold that aligns with the top edge of the batting. Start sewing again with a 1/4" seam allowance.

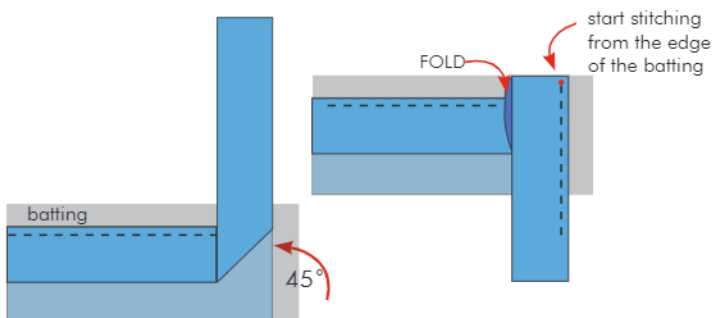

Stop stitching before you reach the last 3 - 4".

Lay the loose ends of the binding flat along the edge, folding the ends back on themselves where they meet. Press them together to form a crease. Sew the two open ends of the binding with right sides together. Trim seam to 1/2" and press open. Complete the sewing.

Turn binding to back of the quilt, fold under and stitch in place.

